

## DESCRIPTION

- Stainless Steel construction
- Flexible supply lines with 3/8" or 9/16" compression fittings
- Includes Red/Blue indicators

## FLOW

- Water usage is limited to these maximum flow rates as indicated by the corresponding product markings
- North America: 1.8 gpm max (6.8L/min) at 60psi
- California: 1.8 gpm max (6.8L/min) at 60psi

## CARTRIDGE

- Ceramic disk cartridge

## STANDARDS

- Certified to CUPC
- Certified to AB1953
- Certified to NSF/ANSI 61

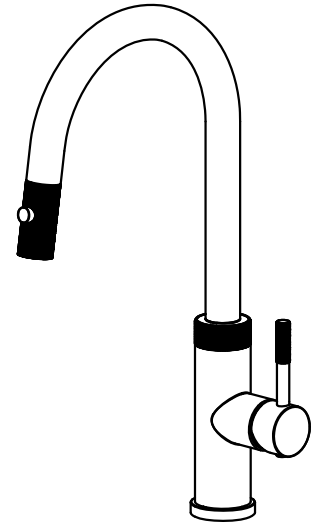

Pull out Kitchen Faucet

**NOTE:** THIS FAUCET IS DESIGNED TO BE INSTALLED THROUGH 1 HOLE,  $\Phi 1\text{-}3/8"$  ( $\Phi 35\text{mm}$ ) MIN.

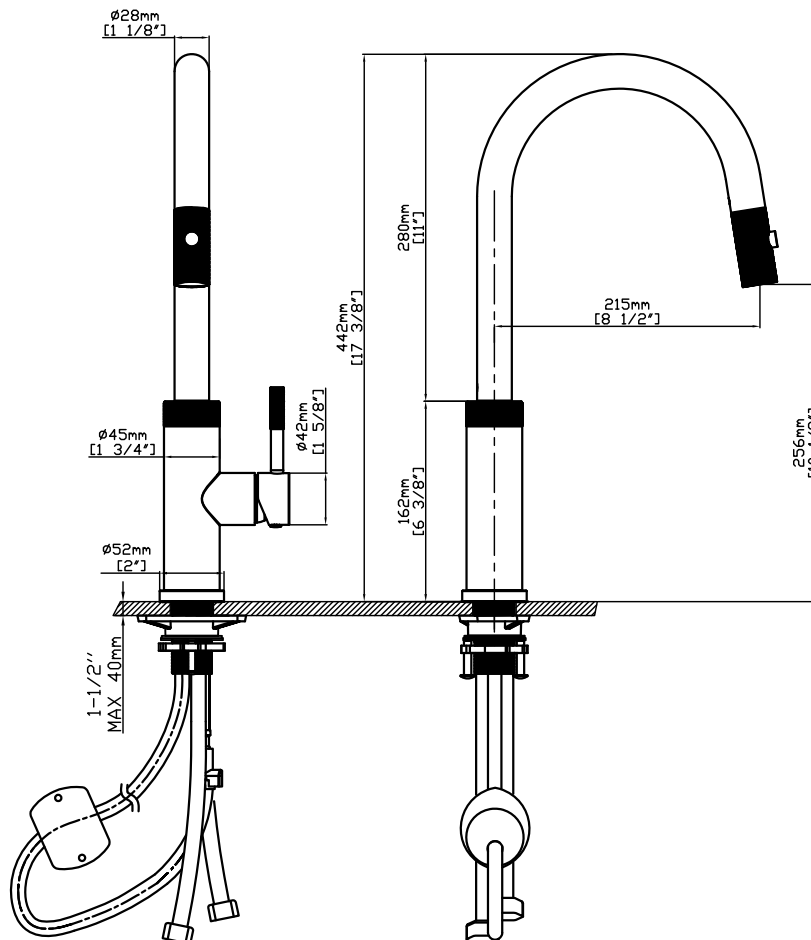

Note: Dimensions are for reference only. Detailed information is in accordance with the final product.

# Pull out Kitchen Faucet Installation

## INSTALLATION MANUAL Tools You Will Need :

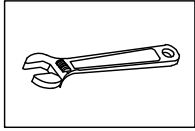

Adjustable wrench

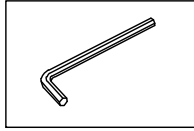

Allen Key

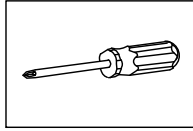

Phillips Screwdriver

### Notes before installation :

1. Please check that all components are present.
2. Before installation ensure that all feed lines are clear of debris and on/off valve is present.
3. Ensure water pressure is between 20-125 PSI (includes combination of hot and cold feed lines).
4. Pictures in the manual are general in content and may not represent exactly your purchased faucet. If you are having difficulties please contact a professional plumber.
5. If you will be away from home for an extended period you should shut off the main water supply.

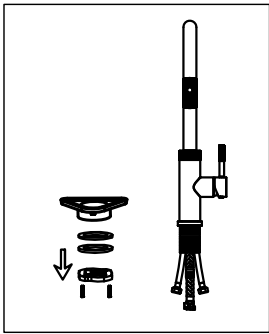

1. Remove lock-nut, metal and rubber washer and hose connector if installed.

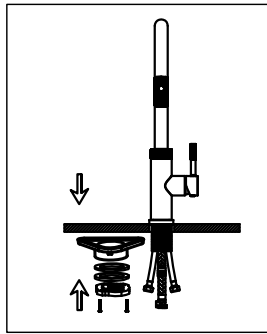

2. Install faucet through center hole, re-install rubber and metal washer followed by the lock-nut. Re-install hose connector if removed insuring small rubber washer is also installed. Using a screwdriver tighten the lock-nut screws so that the faucet is secure and will not twist.

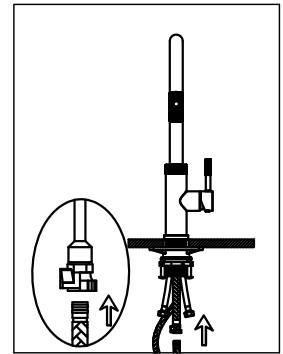

3. Push pull-out hose in to the hose connector until you hear a click sound.

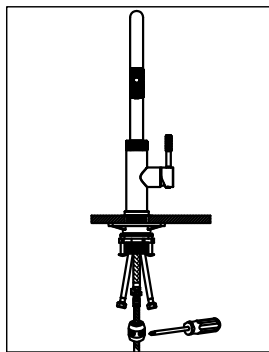

4. Proper installation of the hose weight kit will ensure that the spray head retracts smoothly. On the spray side of the hose, measure 15" down from the body of the faucet. Install the hose weight kit at this point. Pull out on the spray head. It should move easily and retract smoothly. Reposition the hose weight kit as necessary.

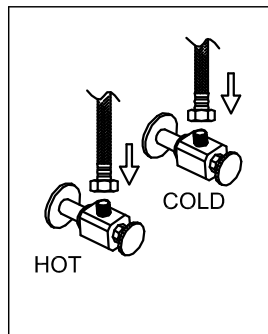

5. Attach flexible hose to water supply.

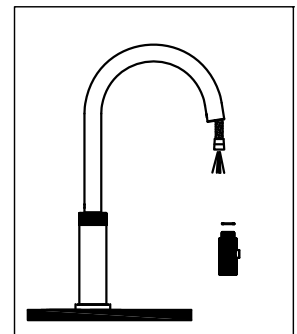

6. Hold on to the spray-head hose, unscrew spray head and remove it along with the rubber washer. Turn on the faucet to flush the hose and feed line for 1-minute to flush debris. Turn off faucet and re-install the rubber washer and spray head.